

design: R&D

POCKET FRAME

LAM32
IDEASBECOMINGLIGHT

Apparecchio pensato per l'installazione fissa ad incasso su pareti e soffitti, finalizzato all'impiego di sorgenti LED COB per luce ambiente asimmetrica. Corpo realizzato in lamiera di acciaio inox verniciato a polveri di poliestere per garantire l'inalterabilità nel tempo e la massima resistenza agli attacchi di agenti atmosferici. Schermo di chiusura in vetro temprato completo di guarnizione O-ring per garantire il grado di protezione IP66. Vano LED estraibile per la messa in opera. Dotato di 50cm di cavo per il collegamento alla linea di alimentazione con sistemi di giunzione stagna non inclusi. Alimentazione a tensione di rete 230VAC.

Luminaire designed for fixed recessed installation on walls and ceilings. Suitable for LED COB sources for asymmetric ambient light. Its body is made of stainless steel sheet submitted to polyester powder coating to guarantee durability over time and maximum resistance against atmospheric agents. The closing screen in tempered glass is completed with gasket O-rings to ensure the protection degree IP66. Removable LED housing for the setting up. It is equipped with a 50cm long cable for connection to the power supply line, through appropriate waterproof connection systems not included. Power supply at mains voltage 230VAC.

POCKET FRAME



IP66



DISEGNO TECNICO/TECHNICAL DRAWING

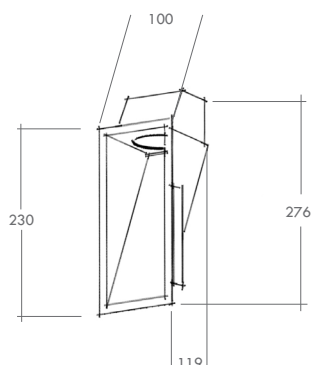

100 x 119 x H276mm
 80x210mm

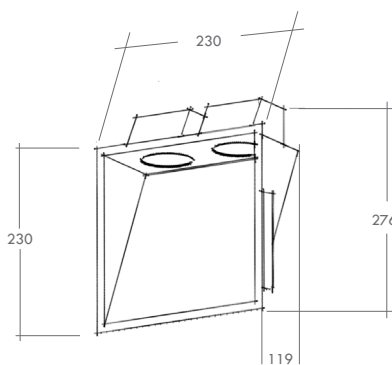

230 x 119 x H276mm
 210x210mm

POCKET FRAME-V

codice/code	sorgente/lamp	lumen/lumens		
		2700K	3000K	4000K
08.102346	LED 1x10W	960	1000	1040

POCKET FRAME-S

codice/code	sorgente/lamp	lumen/lumens		
		2700K	3000K	4000K
08.102347	LED 2x10W	1920	2000	2080

ACCESSORI/ACCESSORIES

codice/code



20.102696

Controcassa per Pocket Frame-V
 Dimensioni 95x151xH297mm.
 Case for Pocket Frame-V
 Sizes 95x151xH297mm.

ACCESSORI/ACCESSORIES

codice/code



20.102697

Controcassa per Pocket Frame-S
 Dimensioni 215x151xH297mm.
 Case for Pocket Frame-S
 Sizes 215x151xH297mm.

ESEMPIO COMPOSIZIONE CODICE / EXAMPLE OF CODE COMPOSITION

08.102346.03.AS.BF

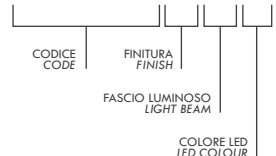

Fascio luminoso/Light beam

.AS asimmetrico/asymmetric

Colore LED/LED Colour

.BC 2700K

.BP 3000K

.BF 4000K

FINITURA/FINISH

colore/colour	codice/code	colore/colour	codice/code	colore/colour	codice/code
	.01 / verniciato bianco painted white		.02 / verniciato nero painted black		.03 / verniciato alluminio painted aluminium
	.04 / verniciato cor-ten painted cor-ten		.11 / verniciato antracite painted anthracite		

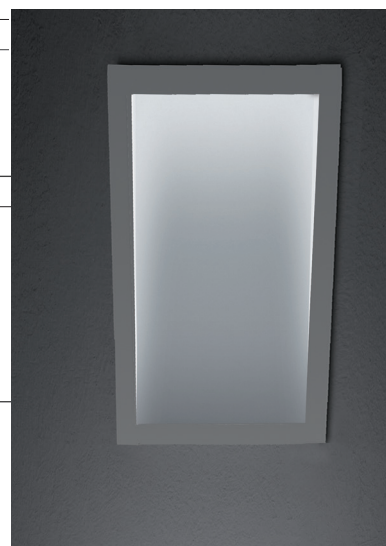

LETTURA DELLA SCHEDA READING THE DATA SHEET

NOME FAMIGLIA
SERIES NAME

MARCHI E REQUISITI
MARKING AND REQUIREMENTS

DISEGNO TECNICO
TECHNICAL DRAWING



design: FABIO ROIELLA

BIN

Apparecchio pensato per l'installazione a pavimento finalizzato all'impiego di sorgenti LED. Corpo con base di fissaggio in lamiera di acciaio inox, piastra porta componenti interna in alluminio verniciato solidale alla base di fissaggio per mezzo di viti in acciaio inox. Completo la struttura una serie di schermi in PMMA opale solidali alla struttura per mezzo di apposito collante sigillante di derivazione navale. Le versioni verniciate sono trattate con polveri di poliestere per garantire l'inalterabilità nel tempo e la massima resistenza agli attacchi degli agenti atmosferici. Tutte le componenti di questa serie possono essere realizzate anche in acciaio inox AISI 316L nelle finiture satinato, per la quale viene applicato uno specifico ed oggettivo trattamento "Anti-Touch" che ne garantisce la pulizia nel tempo, o a richiesta lucido o specchio. L'installazione è consentita mediante l'impiego di viti per il fissaggio diretto a pavimento o mediante accessorio piastra tirafondi in lamiera di acciaio inox con zanche di innestamento per calcestruzzo. Il grado di protezione dell'apparecchio IP65 è garantito dall'apposito sistema pressacavo stagno e da guarnizioni siliconiche. La presenza alimentatore elettronico integrato permette la sua alimentazione a tensione di rete.

Luminaire designed for floor installation, of a body with fixing base in stainless steel in painted aluminum integral with the fixings. The structure is completed by a series of PMMA integral to the structure through appropriate adhesive. Painted versions are processed with polyesters over time and maximum resistance against of this series can be also manufactured in 316L stainless steel, with satin finish, pro "Anti-Touch" treatment to ensure cleanliness. Luminaire's installation is allowed thanks to appropriate flush fixing counter-plate in stainless steel. The protection degree IP65 is guaranteed by the gland system and silicon gaskets. The integrated power supply.

BIN

DISEGNO TECNICO/TECHNICAL DRAWING

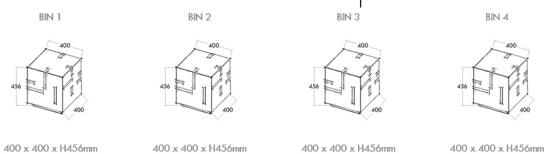

BIN LED

	codice/code	sorgente/lamp	lumen/lumens
			3000K 4000K
BIN 1 LUCE/LIGHT	05.101.227	LED 20,5W	2237 2350
BIN 2 LUCE-AUDIO / LIGHT-AUDIO	05.101.228	LED 20,5W	2237 2350
BIN 3 LUCE-WIFI / LIGHT-WIFI	05.101.229	LED 20,5W	2237 2350
BIN 4 LUCE-AUDIO-WIFI / LIGHT-AUDIO-WIFI	05.101.230	LED 20,5W	2237 2350

FINITURA/FINISH

colore/colour	codice/code
	.05 / inox satinato satin stainless
	.04 / verniciato cor-ten painted cor-ten
	.03 / verniciato grigio painted grey
	.02 / verniciato nero painted black
	.01 / verniciato bianco painted white

ACCESSORI/ACCESSORIES

PIASTRA TIRAFONDI/ANCHOR PLATE	
codice/code	
	20.100379 320mm x 320mm H130mm

ESEMPIO COMPOSIZIONE CODICE / EXAMPLE OF CODE COMPOSITION

Alimentatore elettronico 220/240V 50-60Hz integrato nel corpo dell'apparecchio. Electronic driver 220/240V 50-60Hz integrated in the luminaire's body.

05.101.227.01.BP		Colore LED/LED Colour	
05	101	.BP	3000K
227	01	.BF	4000K

DESCRIZIONE TECNICA DELL'APPARECCHIO
LUMINAIRE TECHNICAL DESCRIPTION

.08/cemento
.06/alluminio lucido o inox lucido
.05/alluminio satinato o inox satinato
.04/verniciato cor-ten
.03 verniciato grigio (RAL 9006) o alluminio anodizzato
.02/verniciato nero (RAL 9005) o anodizzato nero
.01/verniciato bianco (RAL 9016)
.00/naturale

.08/concrete
.06/polished aluminium or polished stainless
.05/satin aluminium or satin stainless
.04/painted cor-ten
.03/painted grey (RAL 9006) or anodized aluminium
.02/painted black (RAL 9005) or black anodized
.01/painted white (RAL 9016)
.00/natural

FINITURE DISPONIBILI
AVAILABLE FINISHES

TABELLA COMPOSIZIONE CODICE
CODE COMPOSITION TABLE





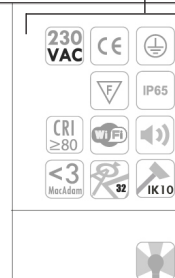









DESCRIZIONE SORGENTE
LAMP DESCRIPTION

CODICE RADICE APPARECCHIO
LUMINAIRE CODE



SIMBOLOGIA SYMBOLS

Configurazioni disponibili/Available configurations

	Apparecchio disponibile in versione RGB (solo per versioni con min. 3 lampade o versioni LED).	Luminaire available in RGB version (only for versions with a min. of 3 lamps or LED versions).
	Apparecchio disponibile in versione CTC (controllo temperatura di colore, solo per versioni con min. 3 lampade o versioni LED).	Luminaire available in CTC version (colour temperature control, only for versions with a min. of 3 lamps or LED versions).
	Apparecchio con possibilità di dimmerazione.	Luminaire has possibility to be dimmed.
	Apparecchio con possibilità di dimmerazione 0/10.	Luminaire has possibility to be dimmed 0/10.
	Apparecchio con possibilità di dimmerazione DALI.	Luminaire has possibility to be dimmed DALI.
	Apparecchio con possibilità di dimmerazione PWM.	Luminaire has possibility to be dimmed PWM.
	Apparecchio disponibile con apparato di diffusione sonora ad induzione.	Luminaire available with induction sound diffusion system.
	Apparecchio disponibile con Router Wi-Fi interno per la diffusione nello spazio circostante di segnali wire-less di ogni genere.	Luminaire available with internal Wi-Fi Router for the diffusion of any kind of wireless signal in the surrounding space.
	Kit emergenza	Emergency Kit
	Apparecchio personalizzabile (con fattibilità da verificare). Modifiche su richiesta: -finitura RAL -dimensione -tecnologia di comunicazione (DALI,WIFI o AUDIO integrato)	Luminaire customizable (with feasibility to be checked). Changes on request: -RAL finish -size -communication technology (integrated DALI,WIFI or AUDIO)
	Apparecchio disponibile a richiesta in versione RGB (solo per versioni con sorgente LED o con minimo 3 lampade).	Luminaire available, on request, in RGB version (only for LED versions or with a minimum of 3 lamps).
	Apparecchio disponibile a richiesta in versione CTC (controllo temperatura di colore, solo per versioni con min. 3 lampade o versioni LED).	Luminaire available, on request, in CTC version (colour temperature control, only for versions with a min. of 3 lamps or LED versions).
	Apparecchio disponibile su richiesta in versione dimmerabile.	Luminaire available, on request, in dimmable version.
	Apparecchio disponibile, su richiesta, con schermo microprismatizzato per elevato comfort visivo.	Luminaire available, on request, with microprismatic screen for high visual comfort.
	Protezione Acqua Stop	Water Stop protection

Protezioni IP/IP Protection degree code

1° CIFRA - Protezione da corpi solidi/

IP1...	Protezione da corpi solidi $\geq 50\text{mm}$
IP2...	Protezione da corpi solidi $\geq 12\text{mm}$
IP3...	Protezione da corpi solidi $\geq 2,5\text{mm}$
IP4...	Protezione da corpi solidi $\geq 1\text{mm}$
IP5...	Protezione da polvere
IP6...	Protezione totale da polvere

1st DIGIT – Protection against solid bodies

IP1...	Protection against solid bodies $\geq 50\text{mm}$
IP2...	Protection against solid bodies $\geq 12\text{mm}$
IP3...	Protection against solid bodies $\geq 2,5\text{mm}$
IP4...	Protection against solid bodies $\geq 1\text{mm}$
IP5...	Protection against dust
IP6...	Total protection against dust

2° CIFRA - Protezione da acqua

IP..1	Protezione da caduta di gocce verticali
IP..2	Protezione da caduta di gocce con inclinazione di 15°
IP..3	Protezione da spruzzi d'acqua con inclinazione di 60° dall'alto
IP..4	Protezione dagli spruzzi d'acqua da ogni direzione
IP..5	Protezione dai getti d'acqua
IP..6	Protezione da inondazioni
IP..7	Protezione contro l'immersione temporanea fino a $30'$ sotto 1m d'acqua
IP..8	Protezione contro l'immersione continua sotto 1m d'acqua



2nd DIGIT – Protection against water

IP..1	Protection against vertically falling drops
IP..2	Protection against vertically falling drops with a tilt angle up to 15°
IP..3	Protection against sprays of water up to 60° from devertical
IP..4	Protection against water spray from all directions
IP..5	Protection against water jets
IP..6	Protection against powerful water jets
IP..7	Protection against temporary immersion up to $30'$ under 1m of water
IP..8	Protection against continuous immersion under 1m of water

Tipologia di alimentazione/Power supply type



Marchi e requisiti/Certificates and requirements

	Apparecchio in classe prima con isolamento elettrico fondamentale. Deve essere collegato al circuito di terra dell'impianto elettrico generale.	Class I Luminaire with basic electrical insulation. It must be connected to the earth circuit of the general electrical system.
	Apparecchio in classe seconda con doppio isolamento elettrico. Non necessita di collegamento al circuito di terra dell'impianto elettrico.	Class II luminaire with double electrical insulation. There is no need for connection to the earth circuit of the electrical system.
	Apparecchio in classe terza predisposto per il collegamento a circuiti a bassissima tensione.	Class III luminaire suitable for connection to extra-low voltage circuits.
	Marchatura CE	CE Marking
	L'apparecchio può essere installato su superfici normalmente infiammabili.	The luminaire can be installed on normally flammable surfaces.
		
	ISO 9001	
	Ellissi di Macadam.	Macadam Ellipse.
	Resistenza al carico statico.	Static load resistance.
	Lunghezza del cavo di alimentazione in dotazione.	Length of supplied power cable.
	Uscita cavo di alimentazione L= Laterale P= Posteriore T= Testa	Cable Output L= Side P= Rear T= Head
	Protezione contro sbalzi di tensione	Protection against sudden changes in voltage.
	Protezione contro l'inversione di polarità	Reverse polarity protection.
	Rotazione dell'apparecchio sull'asse verticale.	Luminaire rotation on vertical axis.
	Inclinazione dell'apparecchio sull'asse orizzontale.	Luminaire inclination on horizontal axis.
	Tipo di emissione luminosa.	Type of light emission.

Resistenza agli urti/Shock resistance

	IK00 Non protetto/ No protection	IK03 0,35 J	IK07 2,00 J
	IK01 0,15 J	IK04 0,50 J	IK08 5,00 J
	IK02 0,20 J	IK05 0,70 J	IK09 10,00 J
		IK06 1,00 J	IK10 20,00 J

Condizioni generali/General Conditions

Le potenze ed i flussi luminosi indicati nel presente catalogo sono riferiti alle sorgenti LED.

Wattage and lumens indicated in this catalogue are referred to the LED sources.

Lam32 srl si riserva il diritto di apportare modifiche ai prodotti della collezione al fine di miglioramento o per esigenza di carattere tecnico e commerciale. Vi invitiamo a consultare il sito www.lam32.com per avere i dati continuamente aggiornati.

Lam32 Ltd reserves the right to make every changes to the products of the this collection, to improve the betterment, or to meet the technical and commercial needs. We invite you to visit the website www.lam32.com, as to have always the data updated.